

Brand ZUCCHETTI

n/a

PAN S

ZPA5772.190E 3 hole built-in basin mixer with aerator.

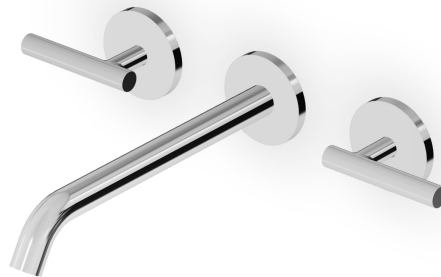

3 hole built-in basin mixer with aerator.
Spout projection 8 11/16".
Water flow restricted to 1,2 GPM.

R99500.190E

Assembled rough-in part, interaxe 8"



R99504.1880

Rough-in part, not assembled, variable distance.



Brand ZUCCHETTI

n/a

PAN S

ZPA5772.190E Finishes



Chrome



Brushed Nickel

C3



Brushed Metal Black

C51



Matt black

N6



PVD brushed chocolate

P21



Brushed PVD British gold

P31



Brushed total black PVD

P81



Glossy gesso

J3



Pearl cipria

K7



Pearl chili

R6



Pearl salvia

V7



Matt mirto

V8

Note / Notes

LOW LEAD

PAN S

ZPA5772.190E Overall Drawing

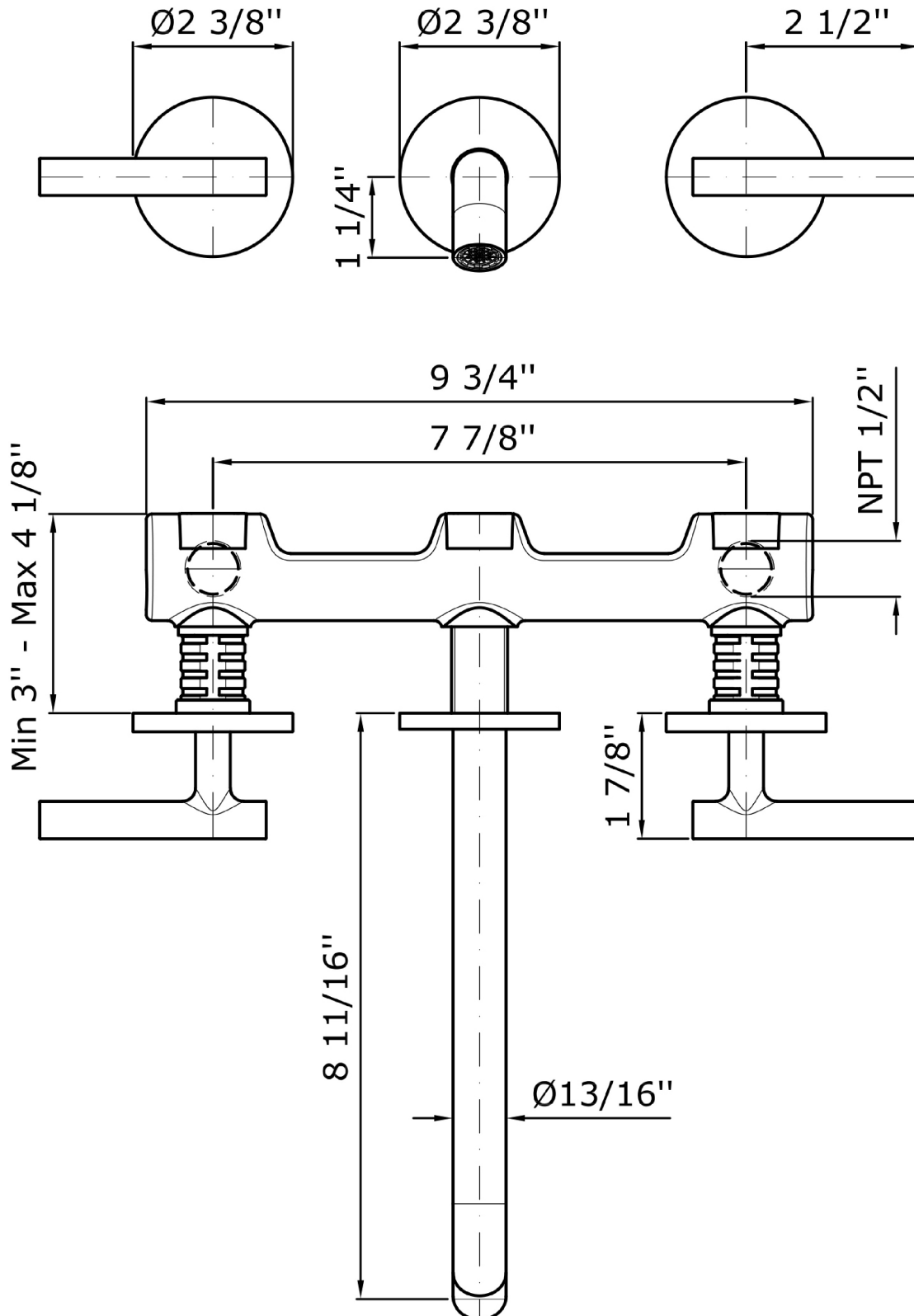

Brand ZUCCHETTI

n/a

PAN S

ZPA5772.190E Weights and Sizes

Weight (lb)	2,30 (Kg)	5,07 (lb)
Volume test (dc3) - (in3)	11,01 (dc3)	671,87 (in3)
h (mm) - (in)	90,00 (mm)	3,54 (in)
L1 (mm) - (in)	335,00 (mm)	13,19 (in)
L2 (mm) - (in)	365,00 (mm)	14,37 (in)

